

1 2 3 4 5 6

A

B

C

D

A4-Kunde V7

A

B

C

D

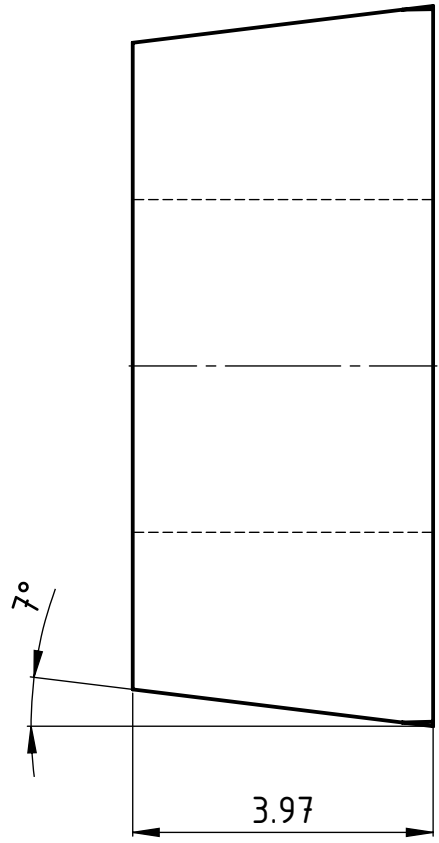
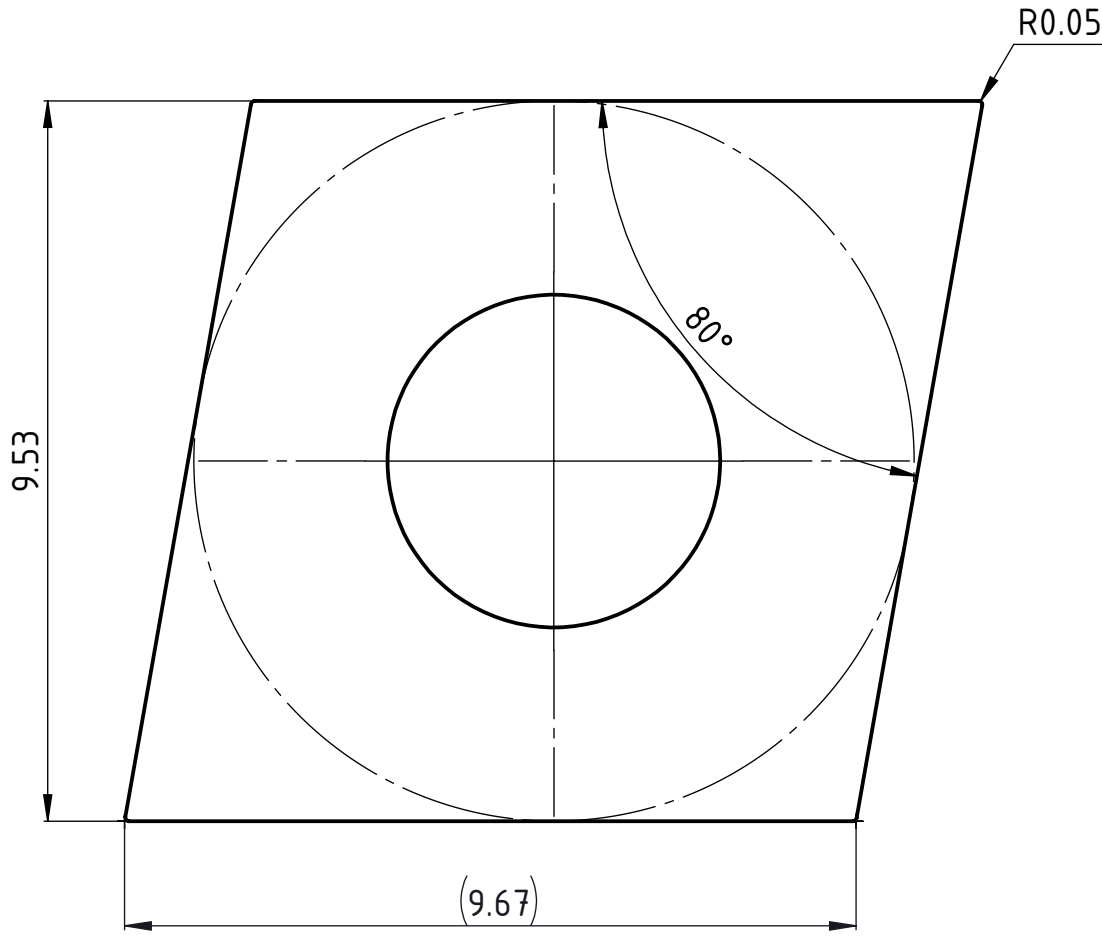

Norm/Norme/Standard
ISO 1832

Freigegeben von am
A.Munishi am 19.09.2019
erstellt von am
T.Forrer am 18.09.2019

Beschreibung
CC.. 09T3005
Artikel Bezeichnung
CC.. 09T3005

UTILIS[®]
Tooling for High Technology
Zeichnungsnummer
CC.. 09T3005

A4
Index
-