

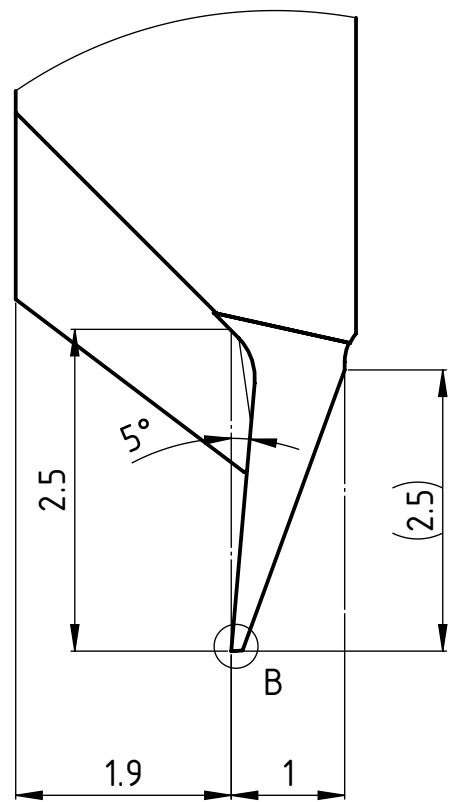

X (15 : 1)

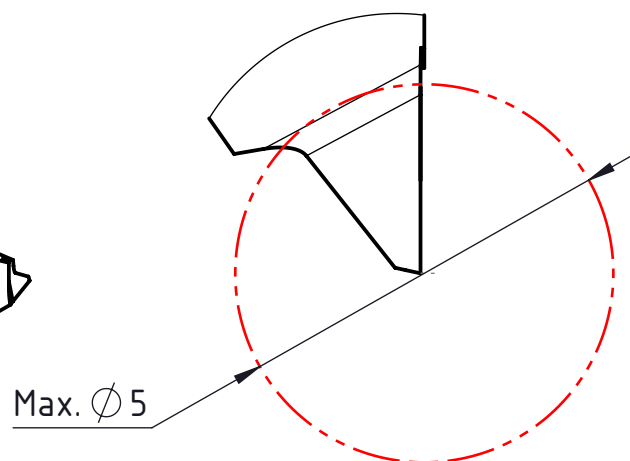

B (100 : 1)

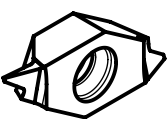
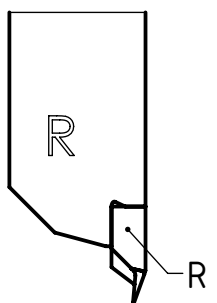
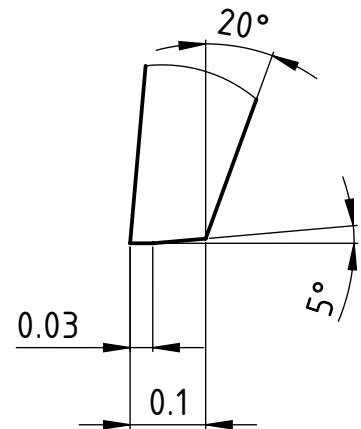

Rechte Ausführung  
Execution droite  
Right execution

Beschreibung <b>multidec CUT WATCH-LINE</b>	Artikel Bezeichnung <b>1604 W-1.0-2.5 R 010/003-20/5/5</b>	Zeichnungsnummer <b>CUT-1708-01</b>	  <b>Index</b> <b>A</b>
--	---	--	--