

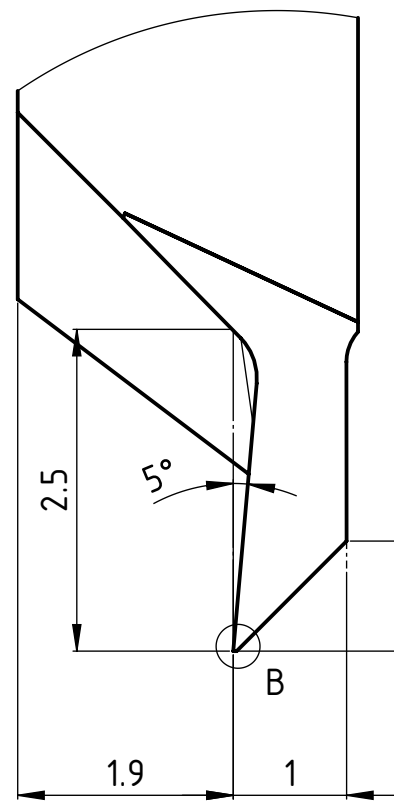

X (15 : 1)

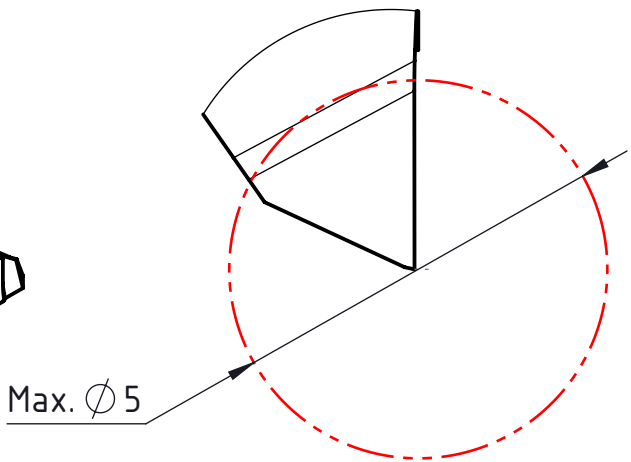

B (100 : 1)

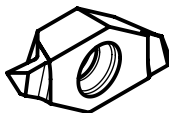
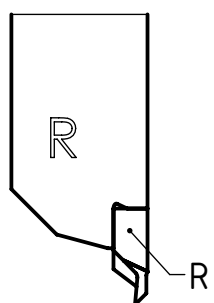
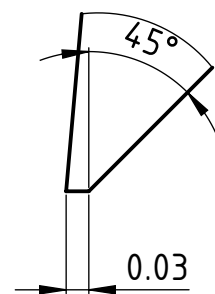

Rechte Ausführung
 Execution droite
 Right execution

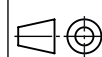
Beschreibung multidec CUT WATCH-LINE	Artikel Bezeichnung 1604 W-1.0-1.0 R 003-45/0/5	Zeichnungsnummer CUT-1799-01	  Index -
--	---	--	--