

1 2 3 4 5 6

A

B

C

A

B

C

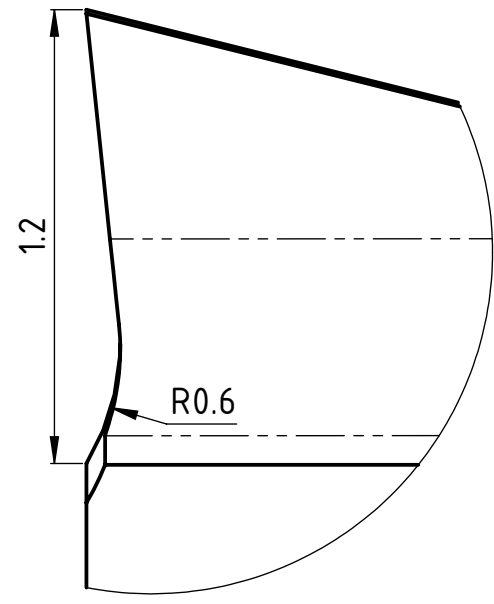
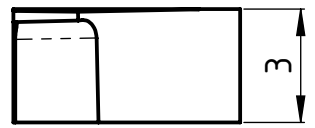
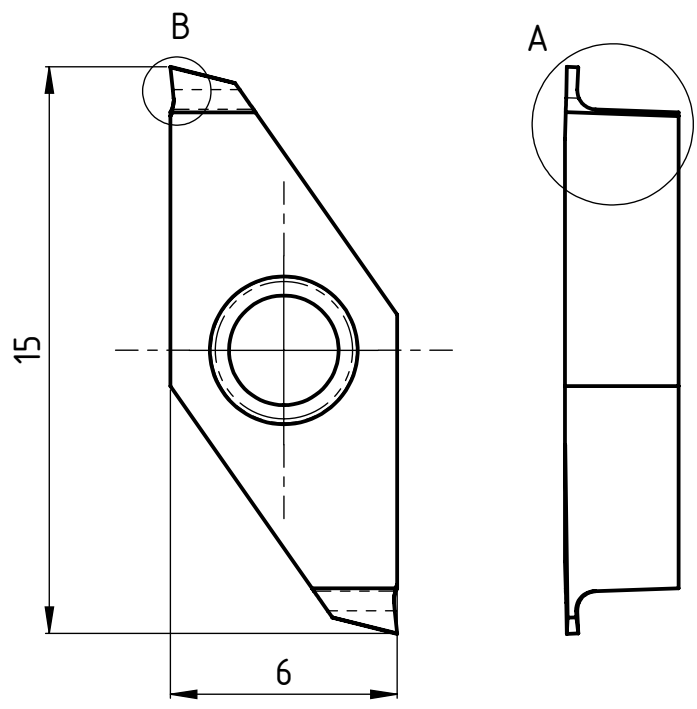

B (50 : 1)

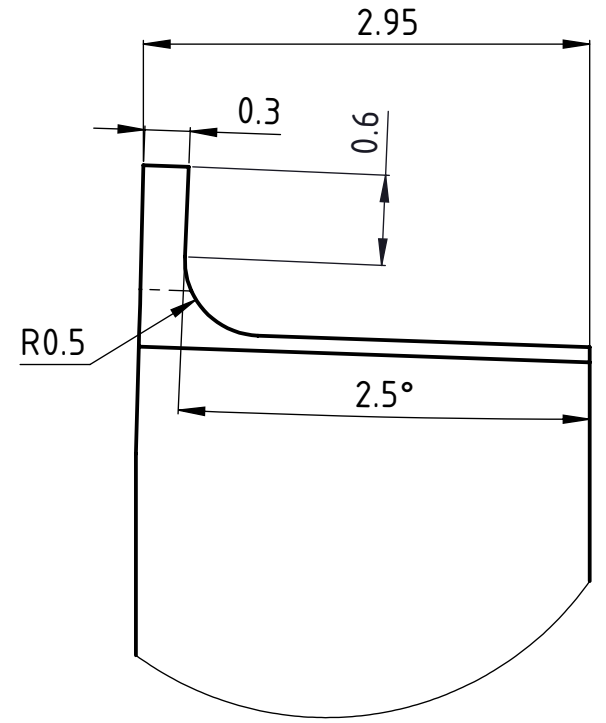

A (20 : 1)

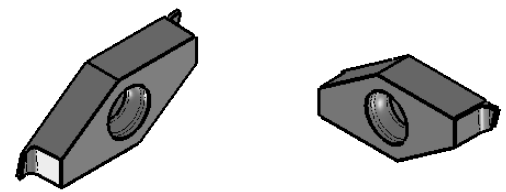

Rechte ausführung abgebildet Linke ausführung CUT-206-07-Z



erstellt von am
O. Bojic am 25.02.2013

Artikel Bezeichnung
1710-0.3-0.6 R

Artikel Nr.
113644

Zeichnungsnummer
CUT-206-08

Index
-