

1 2 3 4 5 6

A

B

C

A

B

C

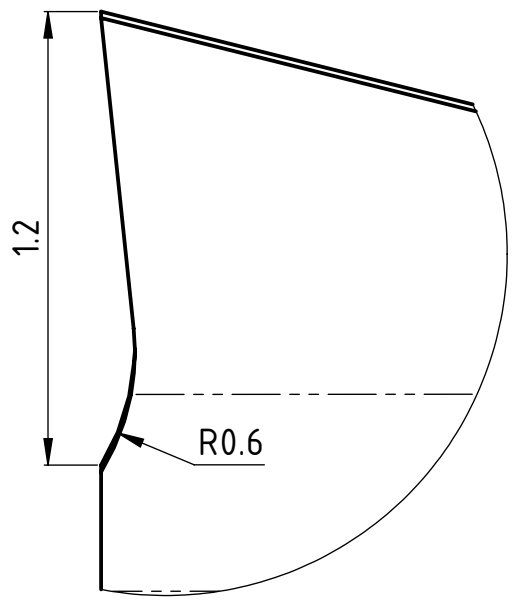
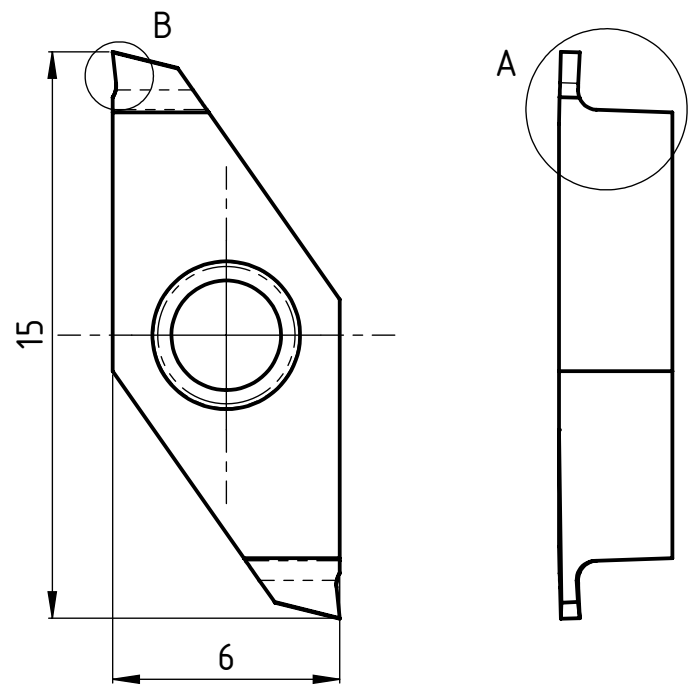

B (50 : 1)

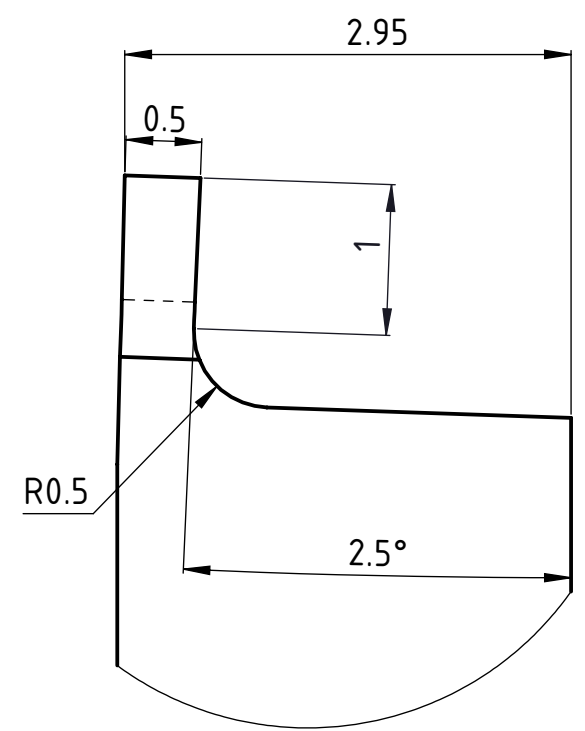

A (20 : 1)

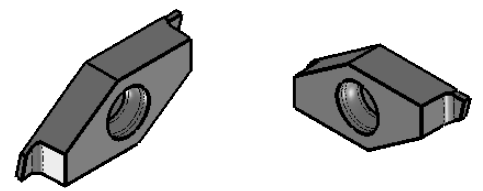
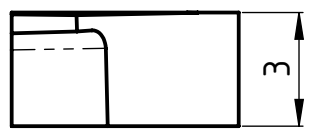

Rechte ausführung abgebildet Linke ausführung CUT-206-11-Z



erstellt von am
O. Bojic am 25.02.2013

Artikel Bezeichnung
1710-0.5-1.0 R

Artikel Nr.
113652

Zeichnungsnummer
CUT-206-12

Index
-