

1 2 3 4 5 6

A

B

C

A

B

C

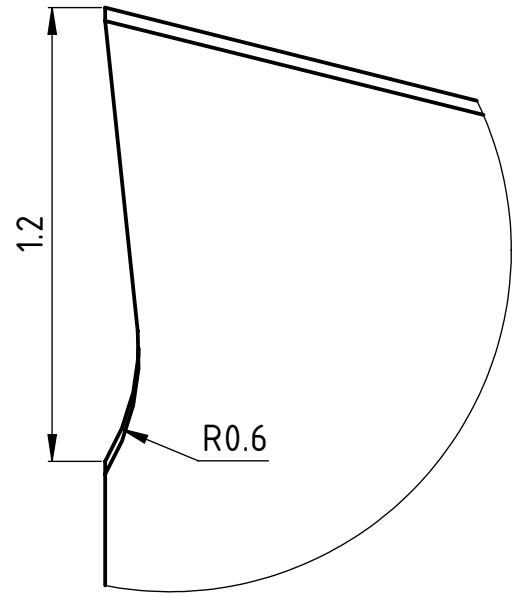
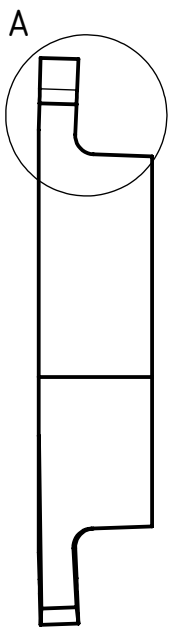
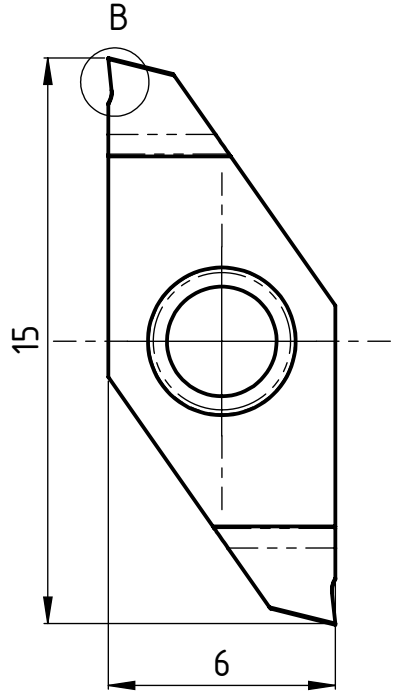

B (50 : 1)

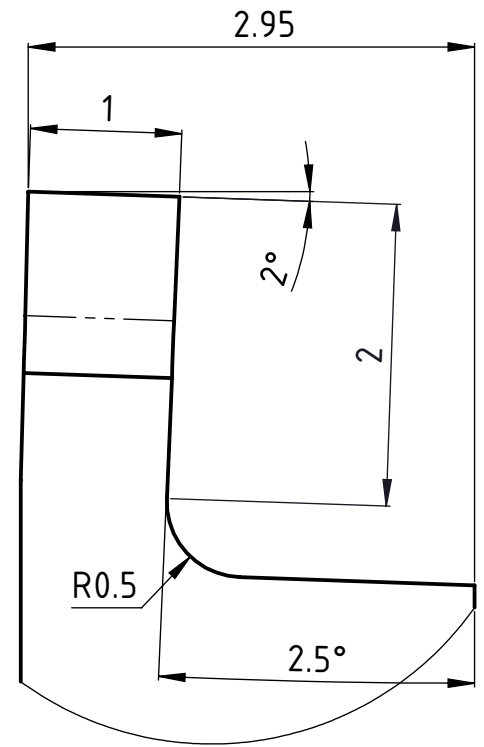

A (20 : 1)

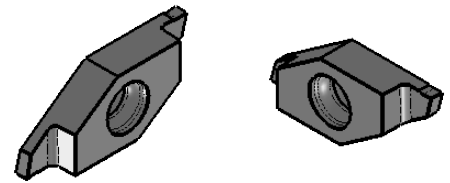
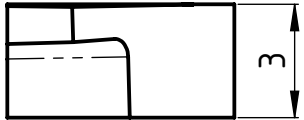

Rechte ausführung abgebildet Linke ausführung CUT-206-19-Z



erstellt von am
O. Bojic am 25.02.2013

Artikel Bezeichnung
1710-1.0-2.0 R

Artikel Nr.
113668

Zeichnungsnummer
CUT-206-20

Index
-