

1 2 3 4 5 6

A
B
C

A
B
C

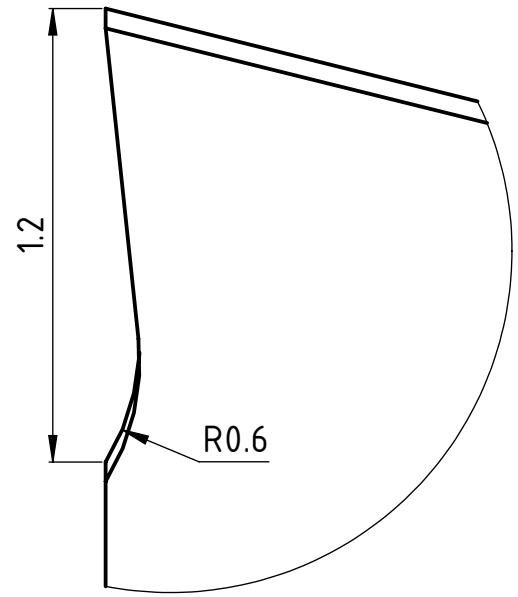
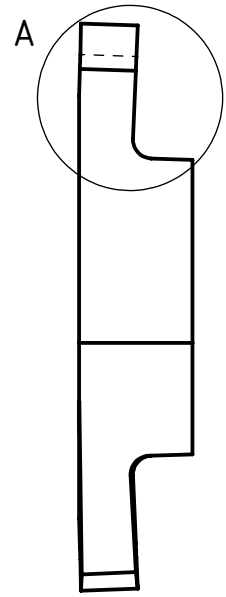
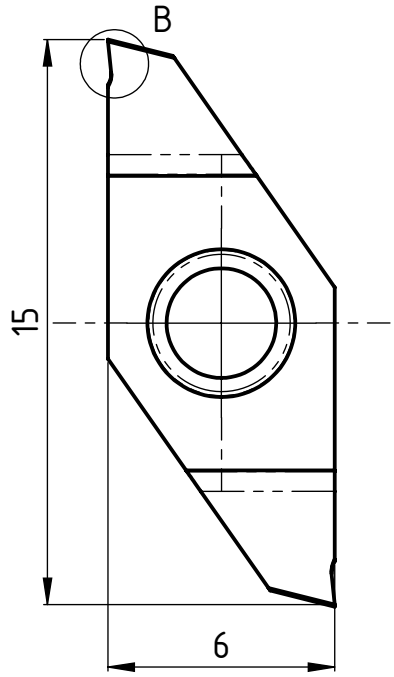

B (50 : 1)

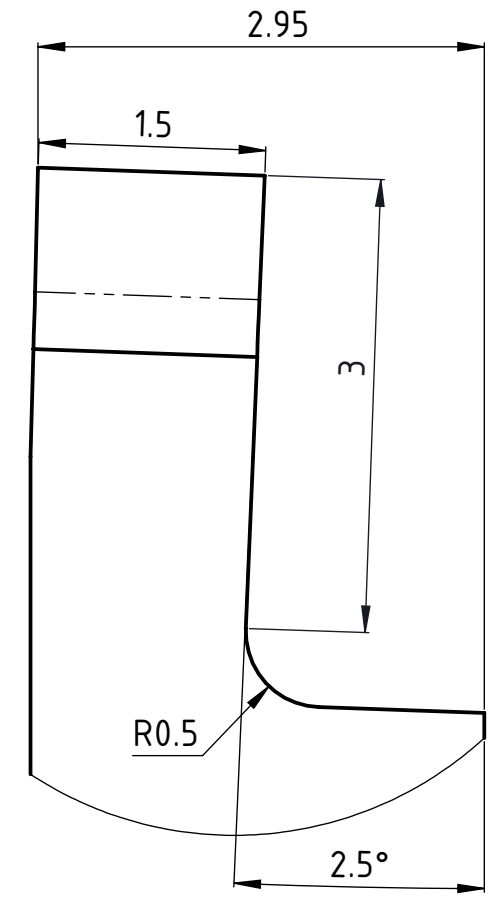

A (20 : 1)

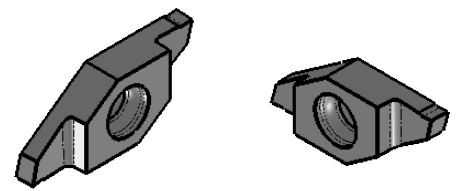
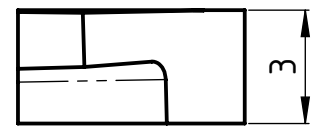

Rechte ausführung abgebildet Linke ausführung CUT-206-21-Z



erstellt von am
O. Bojic am 25.02.2013

Artikel Bezeichnung
1710-1.5-3.0 R

Artikel Nr.
113672

Zeichnungsnummer
CUT-206-22

Index
-