

1 2 3 4 5 6

A
B
C

A
B
C

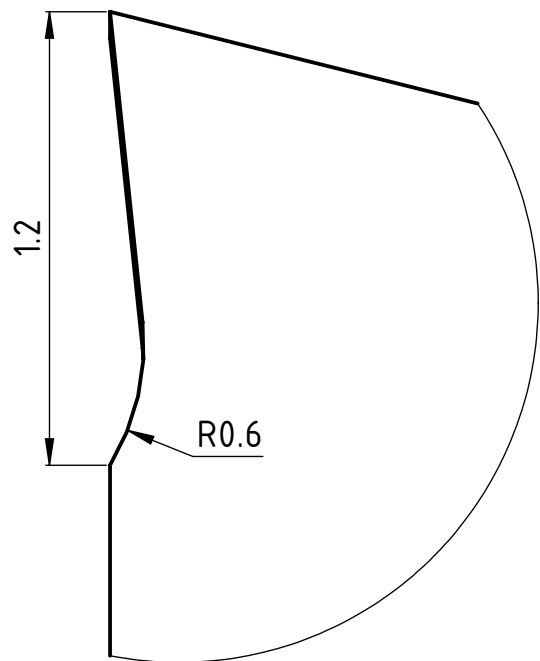
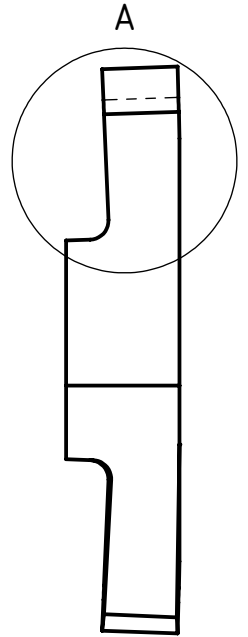
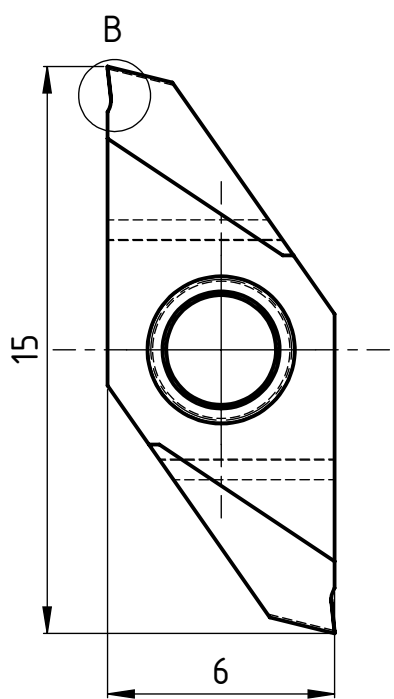

B (50 : 1)

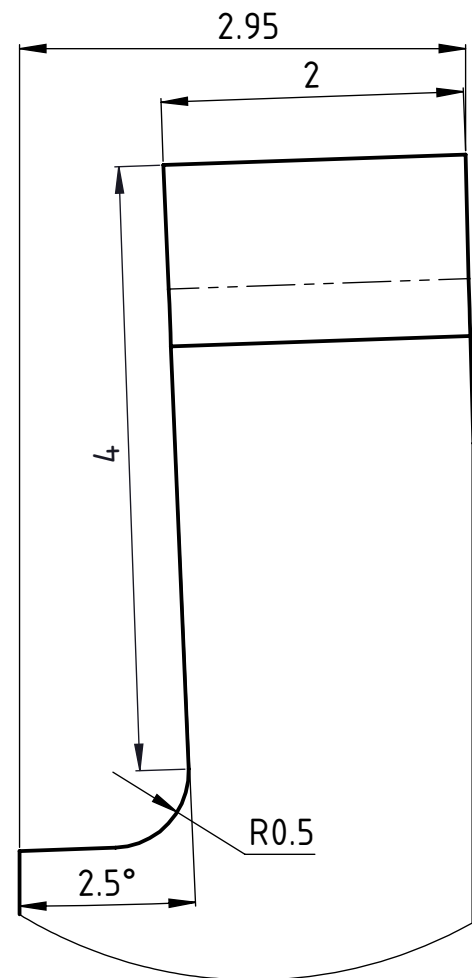

A (20 : 1)

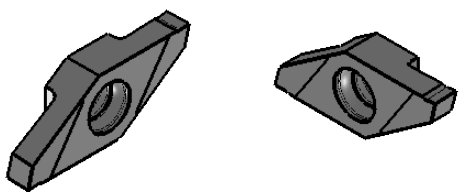
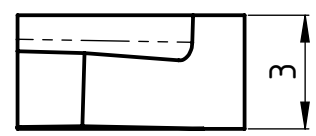

Linke ausführung abgebildet Rechte ausführung CUT-206-24-Z



erstellt von am
O. Bojic am 25.02.2013

Artikel Bezeichnung
1710-2.0-4.0 L

Artikel Nr.
113678

Zeichnungsnummer
CUT-206-23

Index
-