

Y (15 : 1)

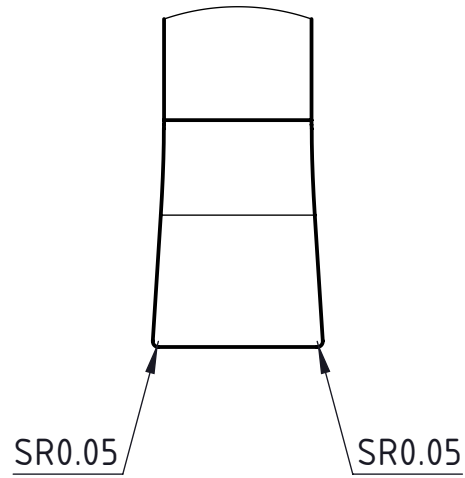

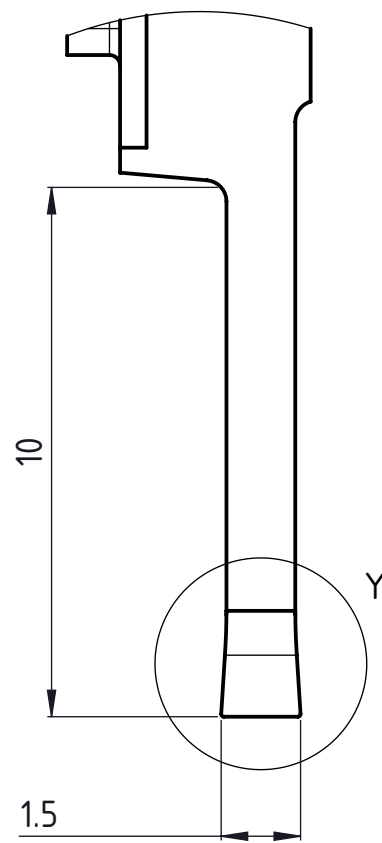

X (7 : 1)

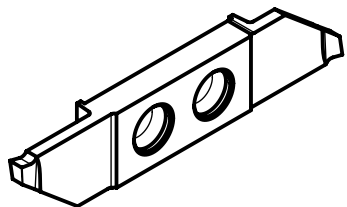
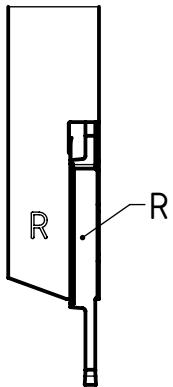
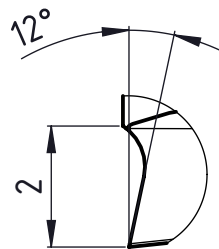

Z (8 : 1)



Rechte Ausführung
 Execution droite
 Right execution

Beschreibung multidec CUT-Wendeplatte	Artikel Bezeichnung 3002-1.5-10 RN SPT12	Zeichnungsnummer CUT-3002-05-101	 Tooling for High Technology	 Index -
-------------------------------------------------	----------------------------------------------------	--------------------------------------------	-------------------------------------------------------------------------------------------------------------------	--------------------------------------------------------------------------------------------------