

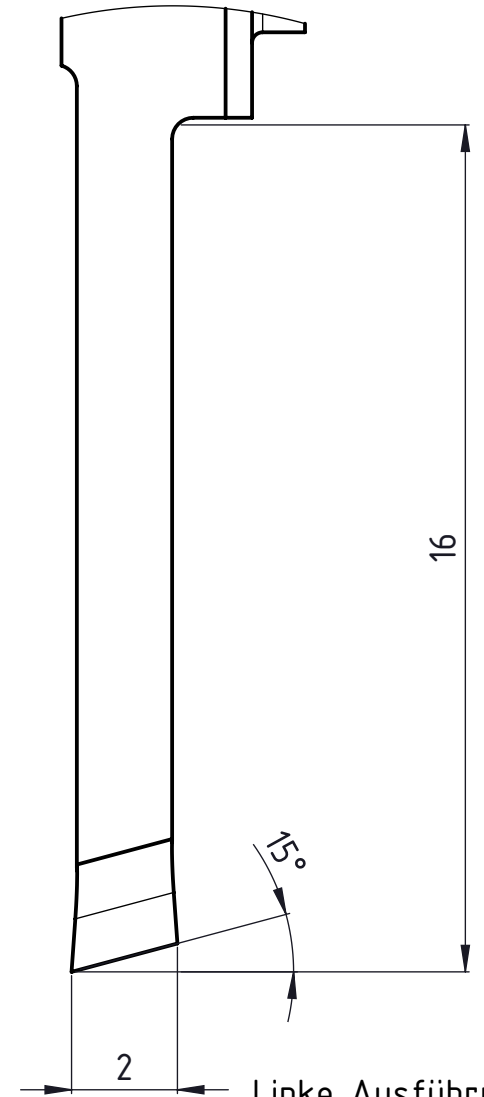

X (7 : 1)

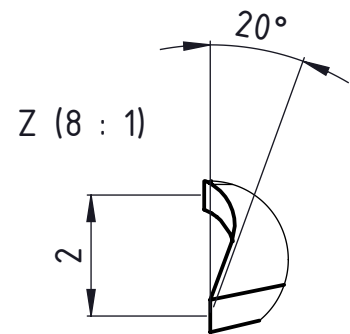
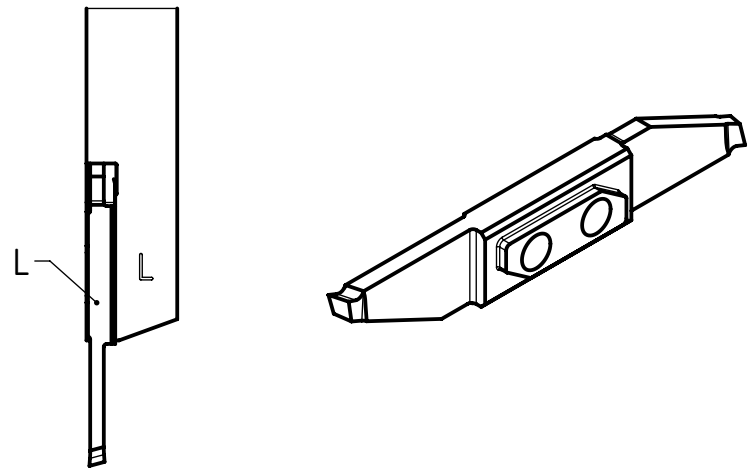
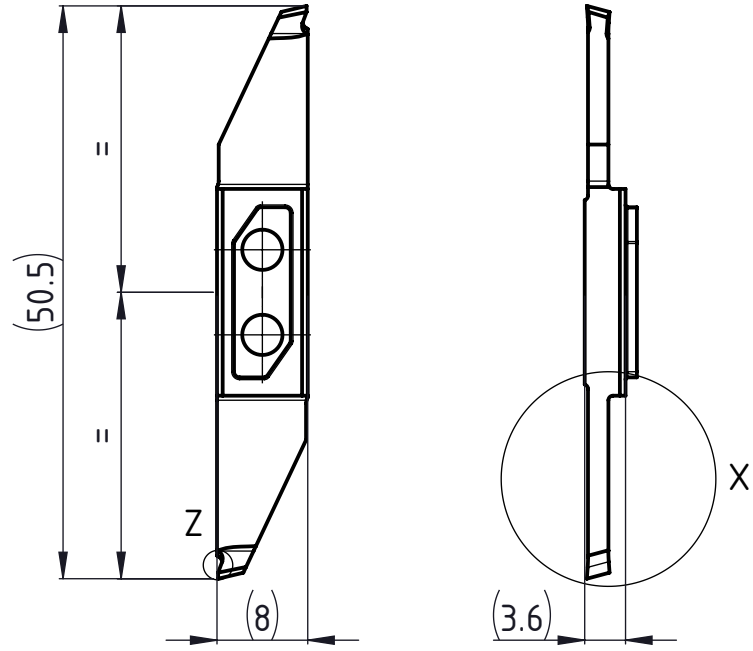

Linke Ausführung
Execution gauche
Left execution

Beschreibung multidec CUT-Wendeplatte	Artikel Bezeichnung 3002-2.0-16 LV SPT	Zeichnungsnummer CUT-3002-05-156	 Tooling for High Technology	 Index -
---	--	--	---	--