

1 2 3 4 5 6

A

B

C

D

A

B

C

D

X (7 : 1)

Y (15 : 1)

SR0.05

SR0.05

Z (8 : 1)

6°

2

Y

15°

2

16

Linke Ausführung  
Execution gauche  
Left execution

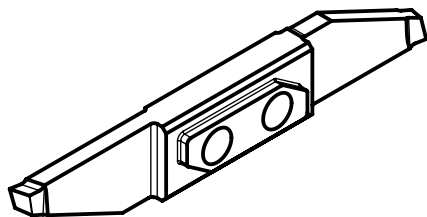
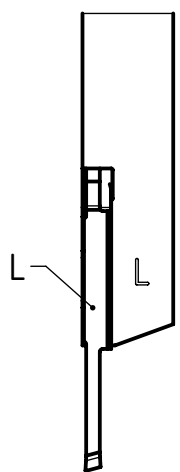
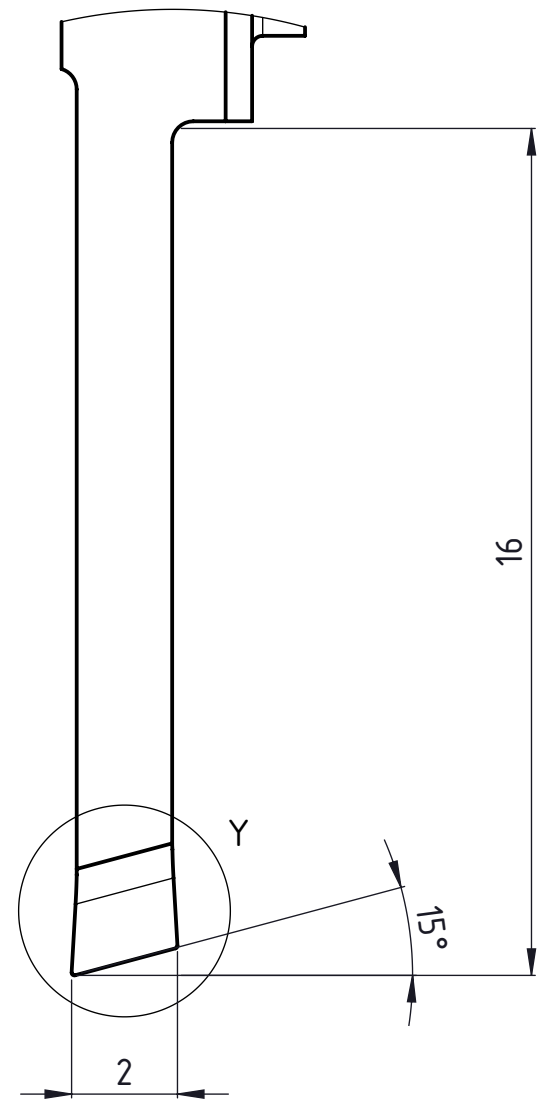
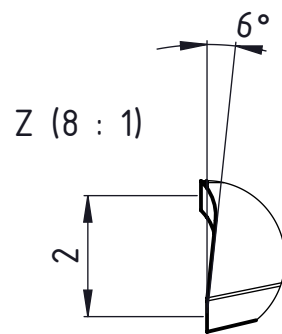
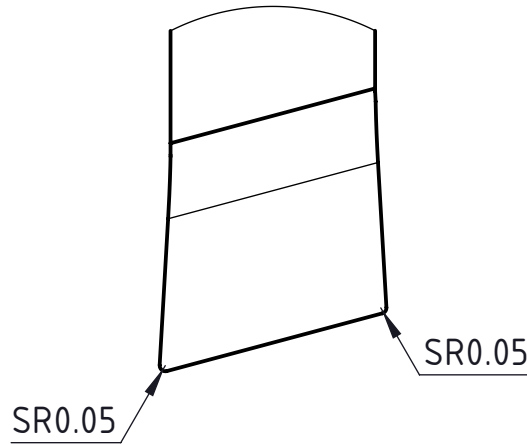
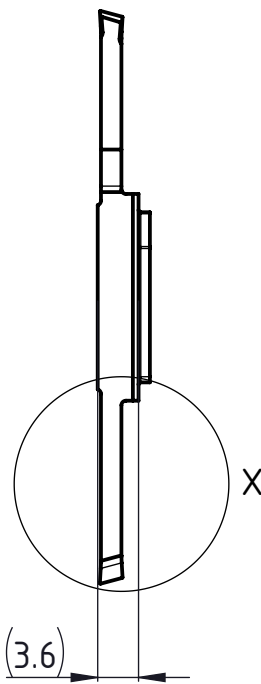
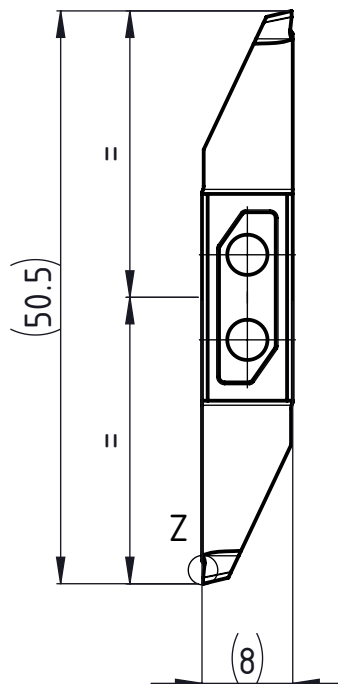

Beschreibung

multidec CUT-Wendeplatte

Artikel Bezeichnung

3002-2.0-16 LV SPT06

Zeichnungsnummer

CUT-3002-05-168

**UTILIS**  
Tooling for High Technology

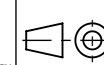

Index  
-