

1 2 3 4 5 6

A
B
C
D

A
B
C
D

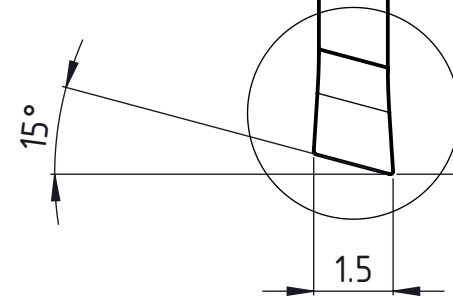
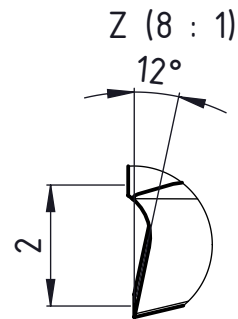
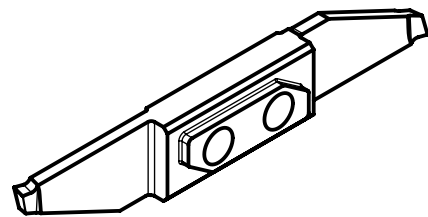
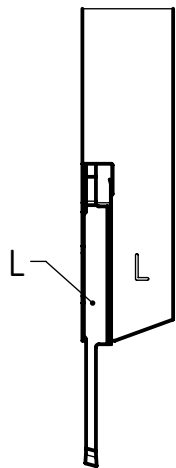
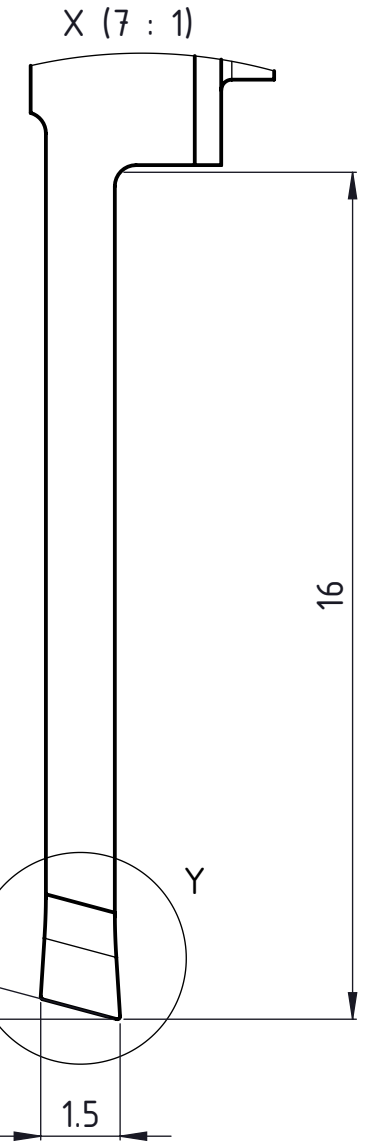
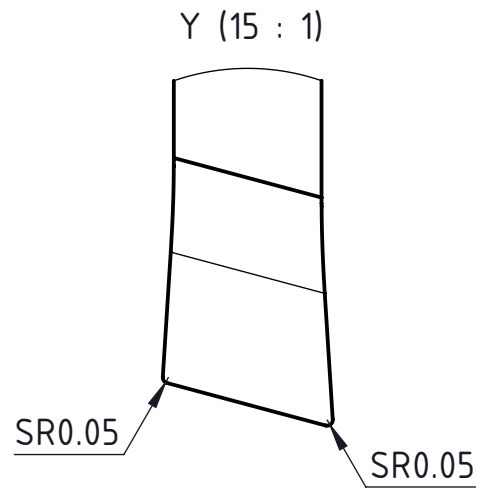
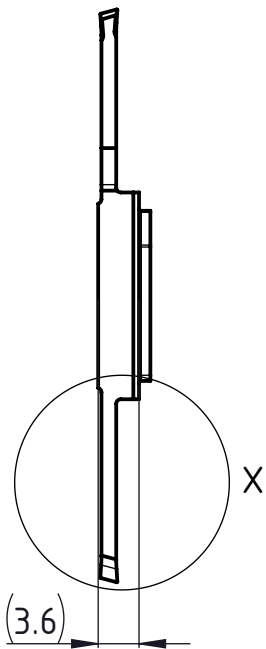
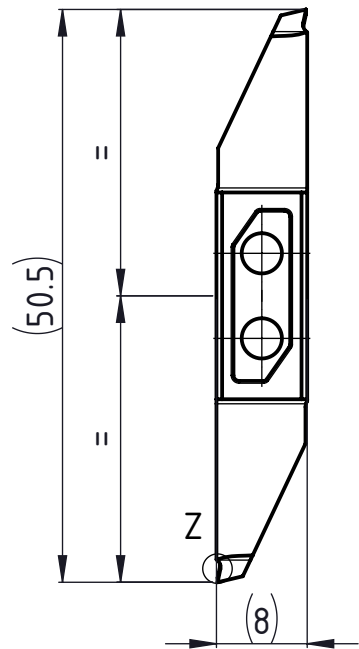

Linke Ausführung
Execution gauche
Left execution

<p>Beschreibung multidec CUT-Wendeplatte</p>	<p>Artikel Bezeichnung 3002-1.5-16 L SPT12</p>	<p>Zeichnungsnummer CUT-3002-05-72</p>	<p>UTILIS[®] <small>Tooling for High Technology</small></p>		<p>Index -</p>
---	---	---	---	--	--------------------