

1 2 3 4 5 6

A

B

C

D

A

B

C

D

X (10 : 1)

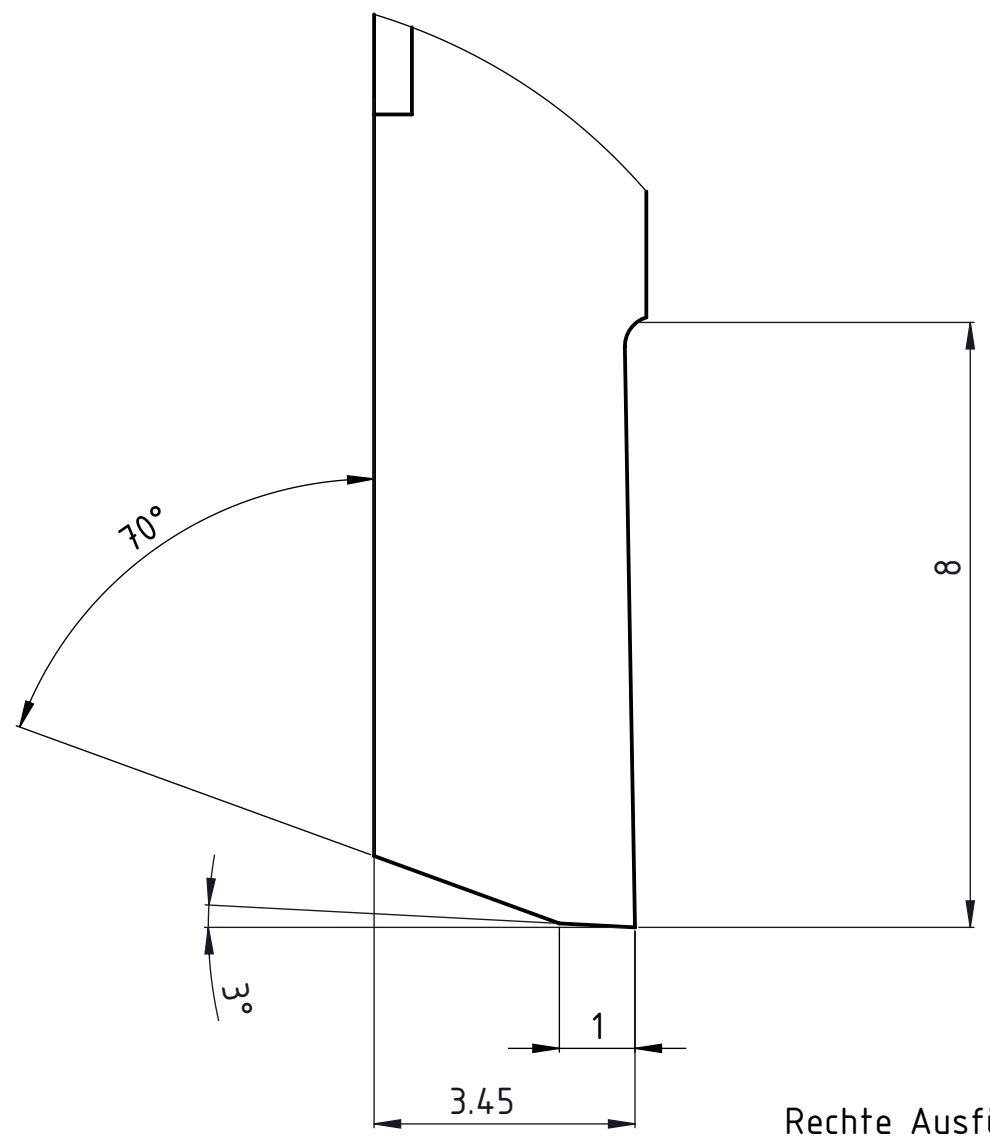
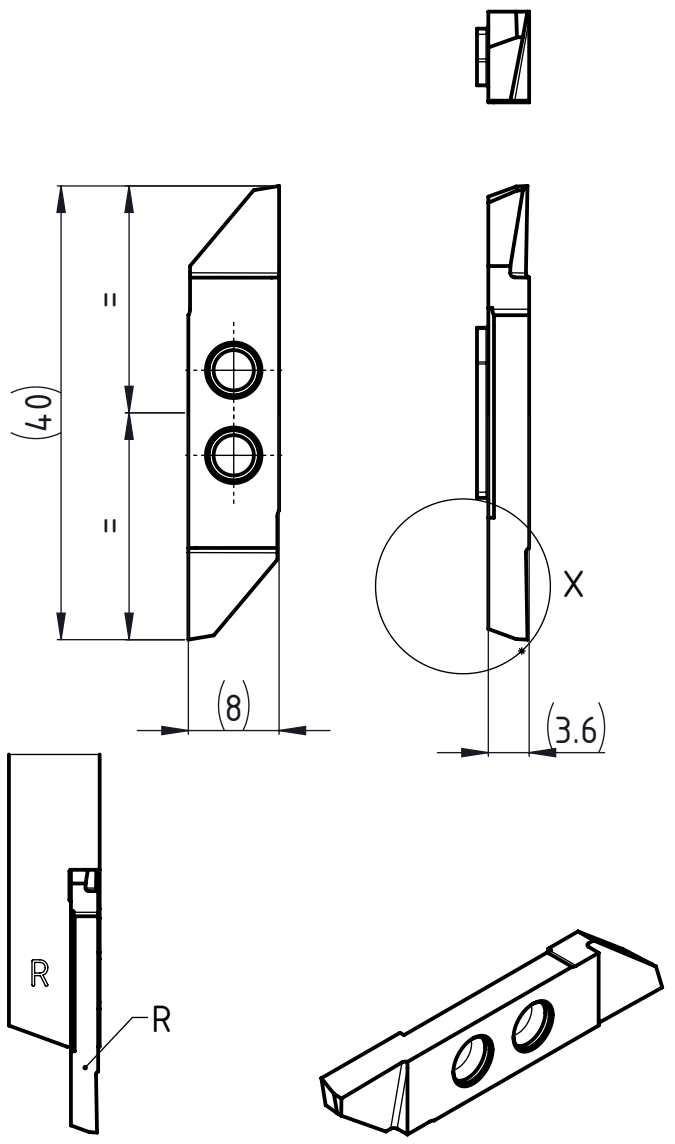

Rechte Ausführung
Execution droite
Right execution

Beschreibung
multidec CUT-Wendeplatte

Artikel Bezeichnung
3003-3.4-8 R

Zeichnungsnummer
CUT-3003-01-09

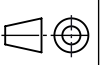

Index
-