

A

B

C

D

A



B

C

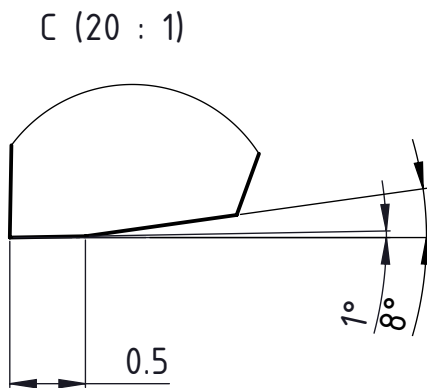
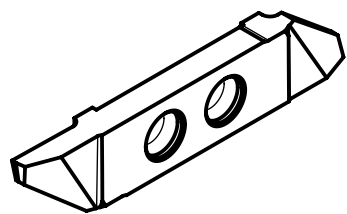
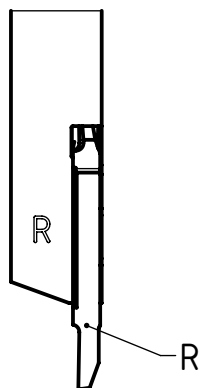
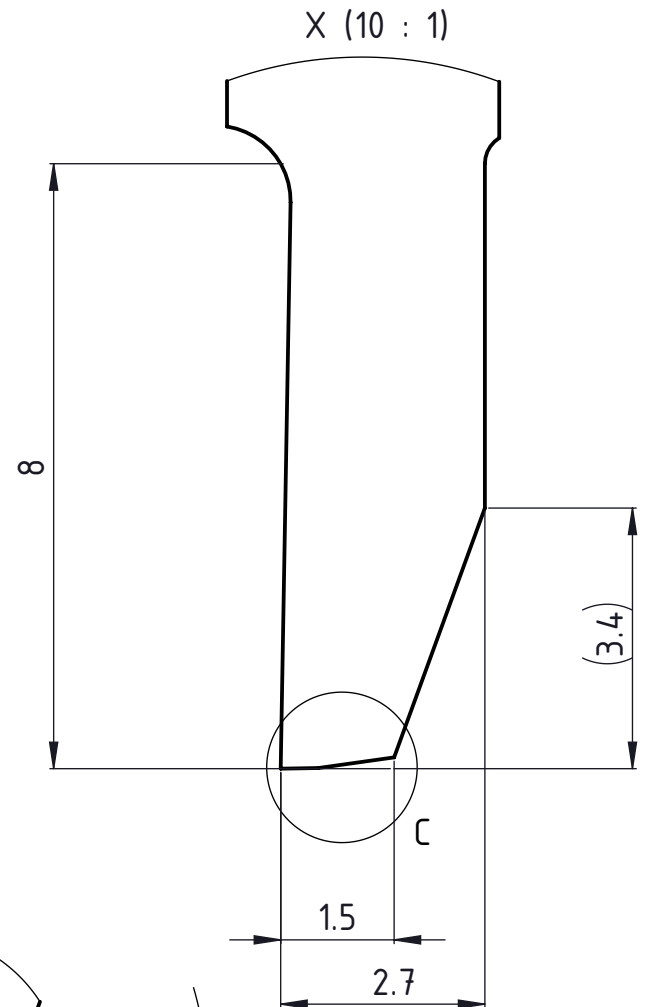
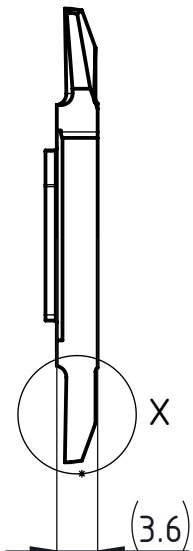
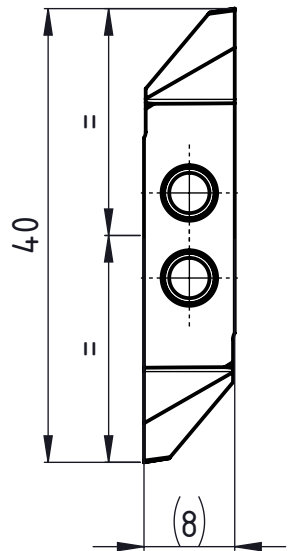
D



Rechte Ausführung
 Execution droite
 Right execution

Beschreibung multidec CUT-Wendeplatte	Artikel Bezeichnung 3004-1.5-8 R TOP ZZ	Zeichnungsnummer CUT-3004-02-07	 <small>Tooling for High Technology</small>	 Index -
---	---	---	---	--