

1 2 3 4 5 6

A

B

C

D

A

B

C

D

X (10 : 1)

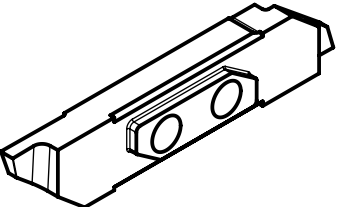
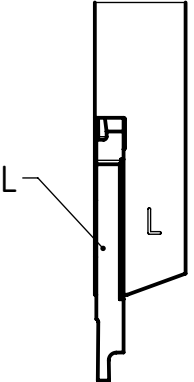
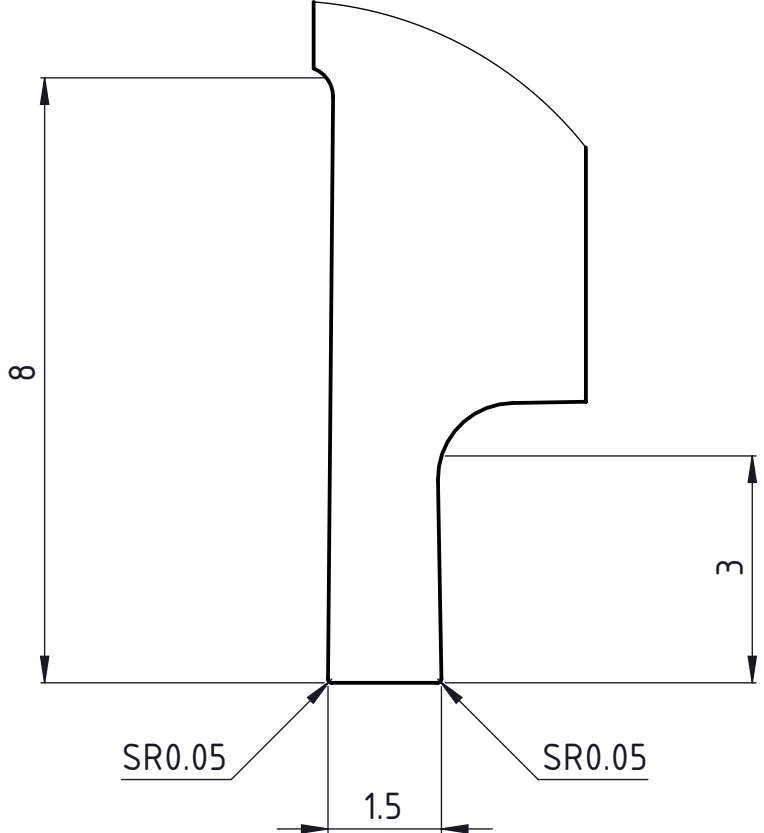
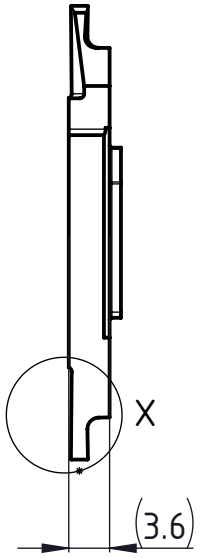
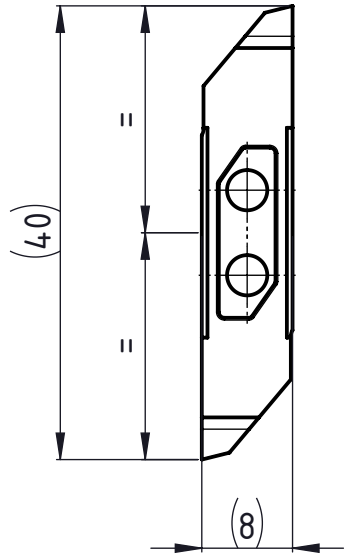

Linke Ausführung  
Execution gauche  
Left execution

Beschreibung  
multidec CUT-Wendeplatte

Artikel Bezeichnung  
3005-1.5-8 L

Zeichnungsnummer  
CUT-3005-01-52

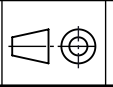

Index  
A