

1

2

3

4

5

A

A

B

B

C

C

D

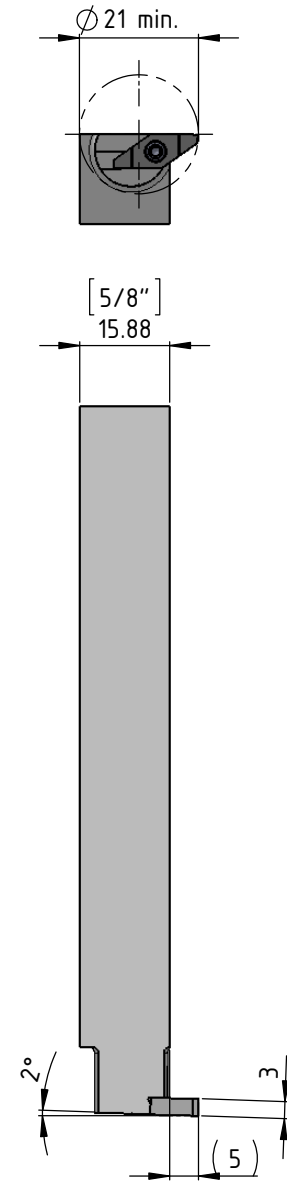
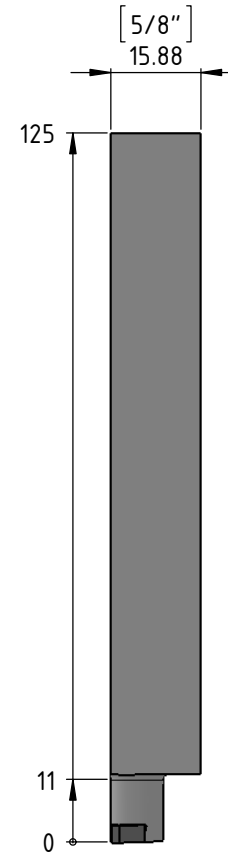
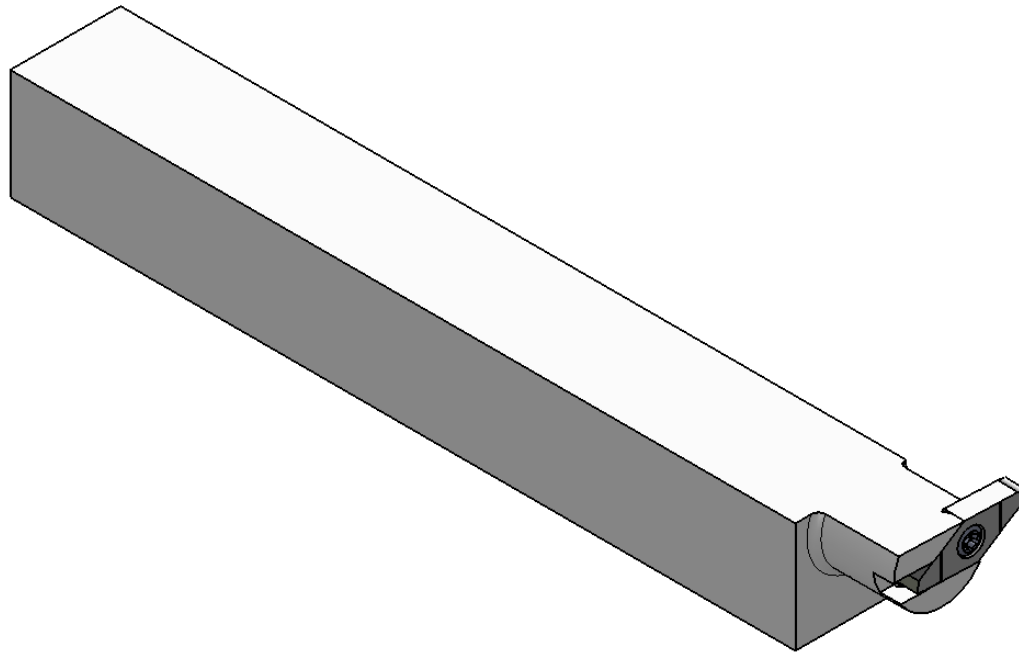

Rechte Ausführung
Exécution droite
Right execution

Artikel Bezeichnung 1700-5/8"x125 92 ST R		Artikel Nr. 113159	erstellt von am T.Forrer am 10.07.2013		Freigegeben von am C.Fabozzi am 10.07.2013	
		Beschreibung Multidec Cut Halter		Format A4	Blatt 2/3	Zeichnungsnummer CUT-45-09
						Index A

Kunde-A4 v1.01

Kunde: Utilis / Kunden Nr. 12026 / Original-Zeichnung

Plotdatum: 12.07.2013