

1 2 3 4 5 6

A

B

C

D

A4-Kunde V7

A

B

C

D

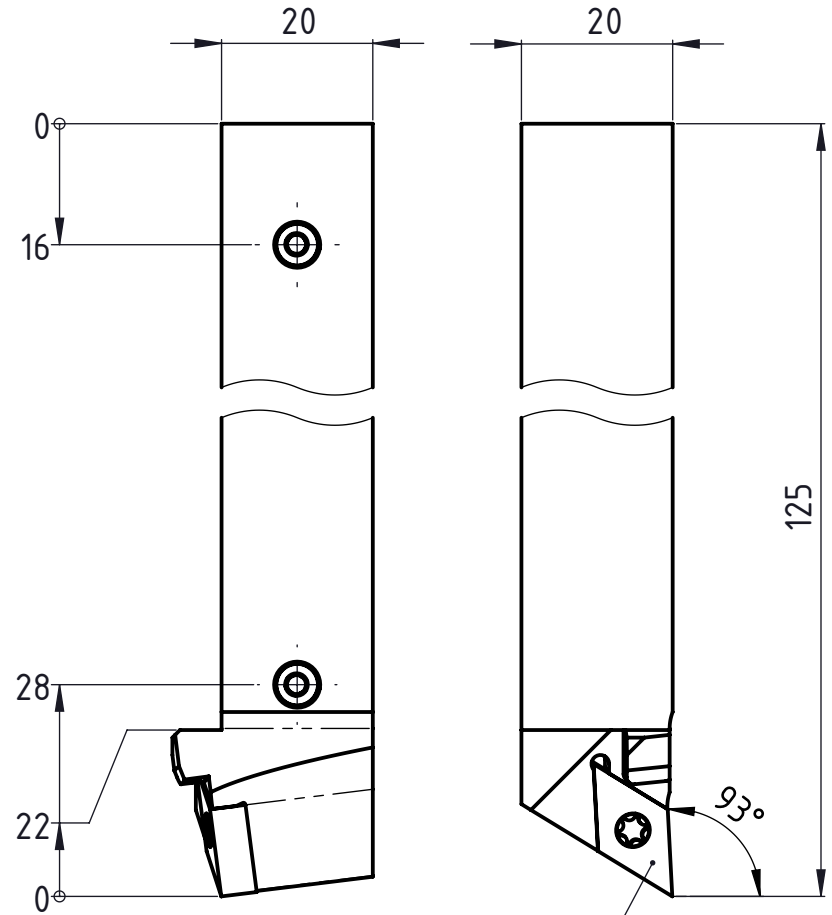
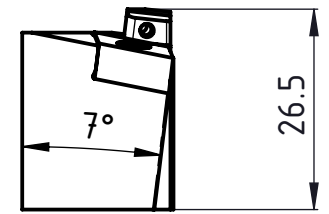
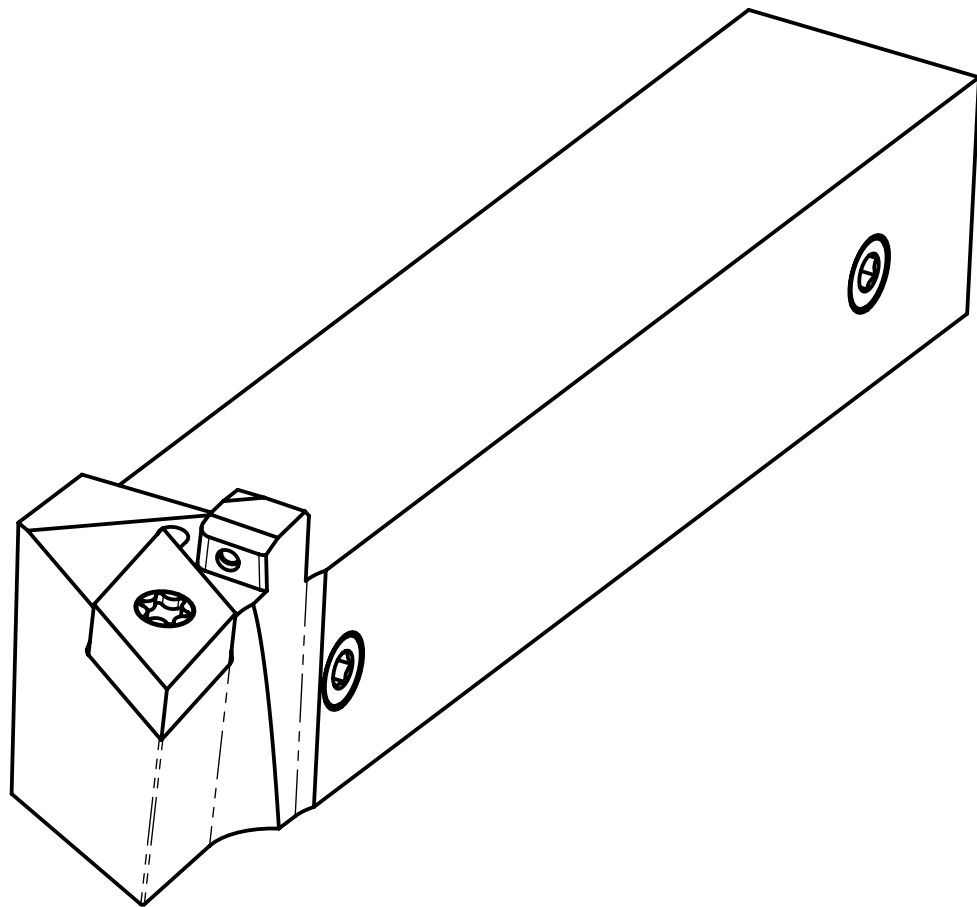

Freigegeben von am
T.Weilenmann am 28.03.2019

erstellt von am
C.Fabozzi am 05.03.2013

Beschreibung
Multidec-ISO Halter

Artikel Bezeichnung
SDJNR 2020 K11 IC

UTILIS[®]
Tooling for High Technology
Zeichnungsnummer
ISO-150-06

A4
Index
B