

1 2 3 4 5 6

A

B

C

D

A4-Kunde V7

A

B

C

D

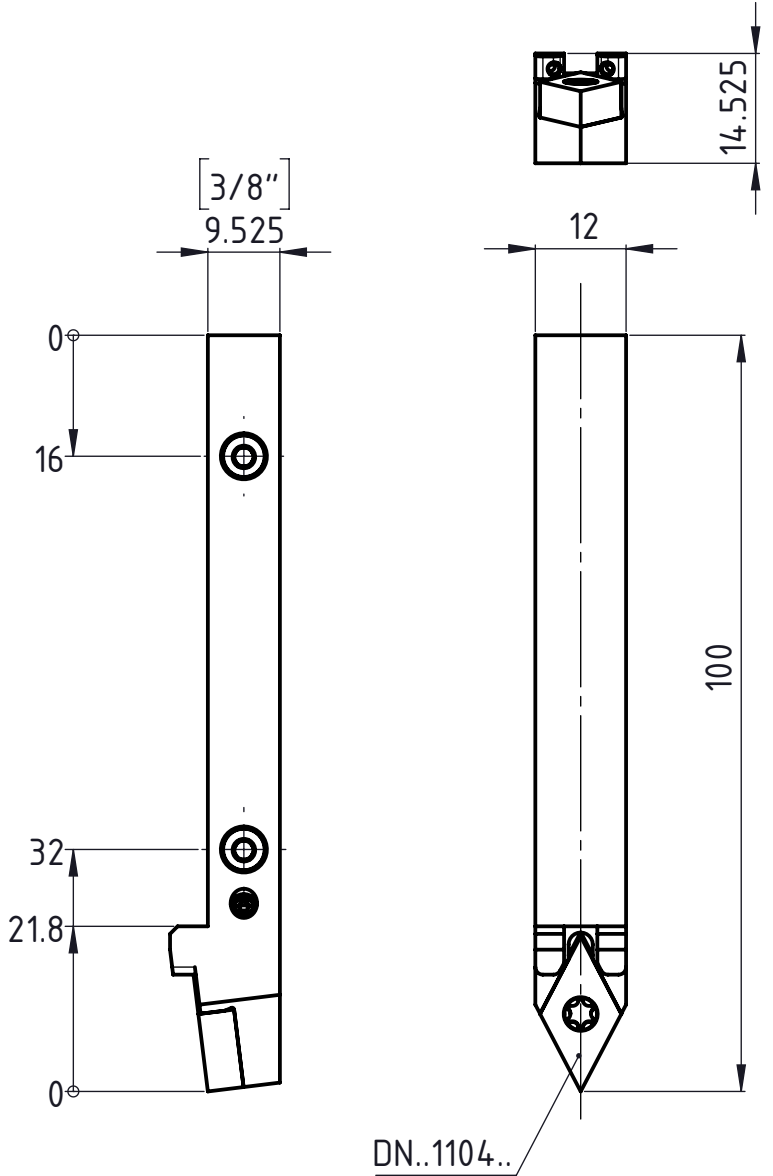
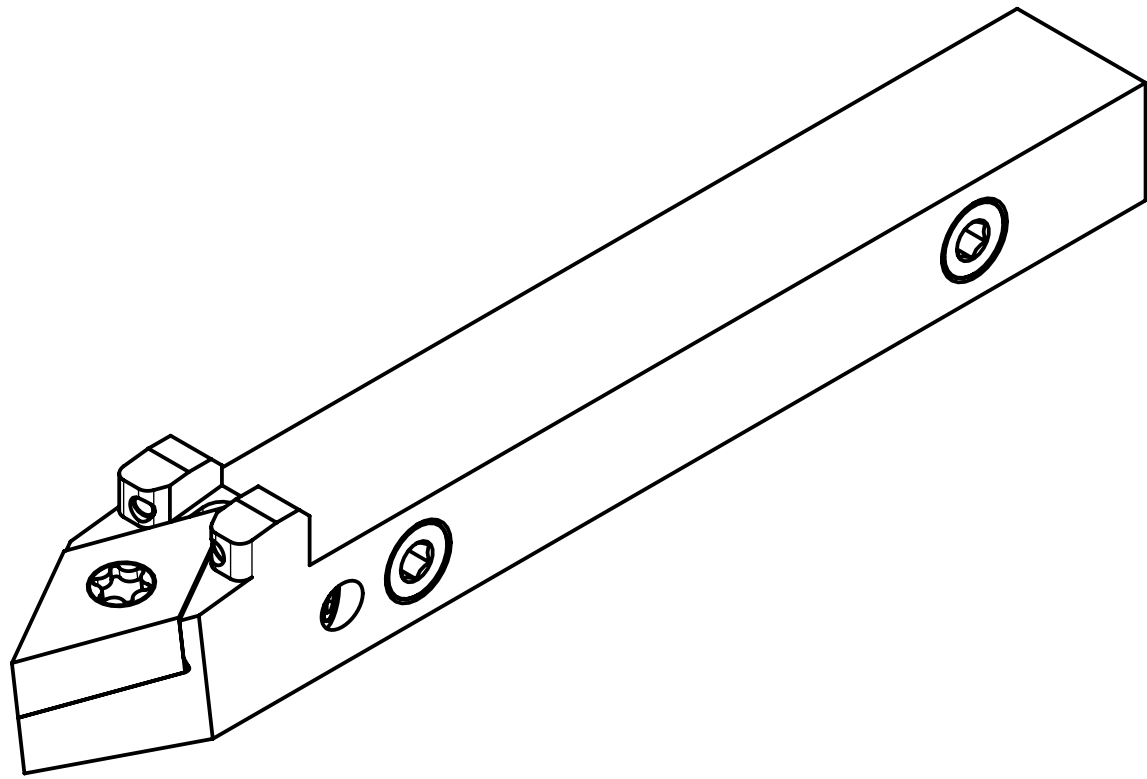

Freigegeben von am

T.Weilenmann am 18.11.2019

erstellt von am

C. Fabozzi am 20.04.2016

Beschreibung

Multidec-ISO Halter

Artikel Bezeichnung

SDNNN 3/8" H11 U IC

UTILIS[®]

Tooling for High Technology

Zeichnungsnummer

ISO-249-15



A4

Index

-